

Conveyor chain

H820	Straight running chain	2	H1702TAB 67Knuckle chain	9
H820	Perforated straight running chain	2	HA600 Knuckle chain	10
H880	Sidflexing chain	2	HA1400 Knuckle chain	10
H880	Perforated Sidflexing chain	2	HA600TAB Knuckle chain	10
H821	Straight running chain	2	HA1400TAB Knuckle chain	10
H880	Non slip sidflexing chain	3	H2012 Case Chain	10
H880TAB	Sidflexing chain	3	H1853 Stainless steel based Straight running chain	11
H880OTABO	Sidflexing chain	3	H963 Stainless steel based Straight running chain	11
H880TAB	Sidflexing chain	3	H1863 Stainless steel based sidflexing chain	11
H880BO	Sidflexing chain	3	H1873 Stainless steel based sidflexing chain	12
H1775	Crescent Sidflexing chain	4	H1873Z Stainless steel based sidflexing chain	12
H1770	Sidflexing chain	4	H402 Spiral machine long chain plate with pad	12
H1050	Sidflexing flat top	4	H1873GD Stainless steel based sidflexing chain	13
H1060	Sidflexing flat top	4	H1873GJ Stainless steel based sidflexing chain	13
HPT250	Sidflexing flat top	4	Hj2013 Dishwasher chain plate	13
H1108A	Knuckle chain	4	HS512 Steel table straight running chain	14
H1108B	Knuckle chain	5	HS815 Steel table straight running chain	14
H1108C	Double row small pitch chain	5	HS881M Steel table sidflexing chain	15
H1108TAB	Sidflexing chain	5	HS881TAB Steel table sidflexing chain	15
H1108STABF	Sidflexing chain	5	HS802Z Steel table straight running chain	16
H700	Straight running chain	6	HS881TABZ Steel table sidflexing chain	16
H822TAB	Sidflexing flat top chain	6	H-PC Small pitch roller chain	16
H822TABF	Sidflexing flat top chain	6	XS44 Flexible chain	17
H822TAB-GD/GJ	Sidflexing chain	6	XL63 Flexible chain	17
HPB821	Roller top Straight Belt	7	XM83 Flexible chain	17
HPBF821	Roller top Straight Belt	7	XH103 Flexible chain	17
H8275	Roller top Straight Belt	8	Transmission system	18
HPB882	Roller top Straight Belt	8	Beam	18
H1700	52keel chain	9	Idler end	19
H1702	53keel chain	9	Horizontal wheel bend	19



Plastic Flat Top Chain

H820

Straight running chain

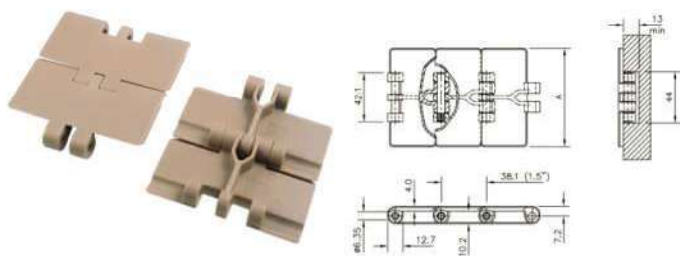

Unit:mm

Chain code	Name	D	K	Pitch	Materials
H820-K250	63 Plastic flat top chain	6.35	63.5	38.1	POM
H820-K325	82 Plastic flat top chain	6.35	82.5	38.1	POM
H820-K343	87 Plastic flat top chain	6.35	87	38.1	POM
H820-K350	89 Plastic flat top chain	6.35	88.9	38.1	POM
H820-K400	101 Plastic flat top chain	6.35	101.6	38.1	POM
H820-K450	114 Plastic flat top chain	6.35	114.3	38.1	POM
H820-K600	152 Plastic flat top chain	6.35	152.4	38.1	POM
H820-K630	160 Plastic flat top chain	6.35	160	38.1	POM
H820-K670	170 Plastic flat top chain	6.35	170	38.1	POM
H820-K750	190 Plastic flat top chain	6.35	190.5	38.1	POM

H820

Perforated straight running chain

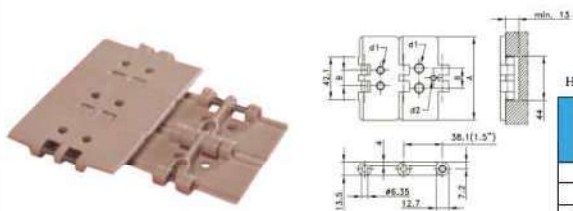

HN20 带孔规格表

Chain Code 产品编号	Width 链宽 (A)		Working Load(max) 工作载荷		Weight 重量 Kg/m	Backflex R (min) 反向转弯半径		Distance between holes (孔间距 B)	Hole Dia 孔径(d1)
	mm	inch	N(21°C)	lbf(21°C)		mm	inch		
820-K325 V2	82.6	3.25	1230	276	0.83	40	1.57	19	6.5
820-K350 V2	88.9	3.50			0.87			45	4.0
820-K450 V2 130	114.3	4.50			1.03			30	8.0
820-K450 V2 150	114.3	4.50			1.03			50	8.0
820-K325 V3	82.6	3.25			0.83			20	7.9

H880

Sideflexing chain

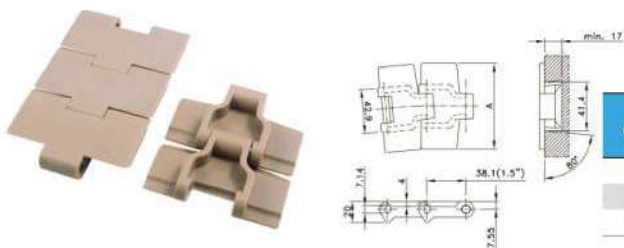

Unit:mm

Chain code	Name	K	R min	Pitch	Materials
H880-K325	82 sideflexing chain	82.5	457	38.1	POM
H880-K350	89 sideflexing chain	88.9	470	38.1	POM
H880-K450	114 sideflexing chain	114.3	500	38.1	POM

H880

Perforated sideflexing chain

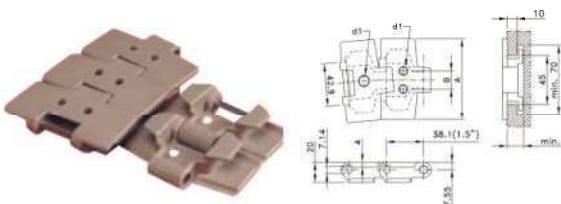

Chain Code 产品编号	Width 链宽 (A)		Working Load(max) 工作载荷		Weight 重量 Kg/m	Backflex R (min) 反向转弯半径		Distance between holes (孔间距 B)	Hole Dia 孔径(d1)
	mm	inch	N(21°C)	lbf(21°C)		mm	inch		
880-K325 V1 D6	82.6	3.25	2100	472	0.83	40	1.57	-	6.5
880-K325 V1 D8	82.6	3.25			0.83			-	8.0
880-K325 V1 D10	82.6	3.25			0.83			-	10.0
880-K325 V2 D6	82.6	3.25			0.83			24	6.0
880-K325 V2 D8	82.6	3.25			0.83			20	8.0
880-K450 V2 D6	114.3	4.50			1.03			24	6.0

H821

Straight running chain

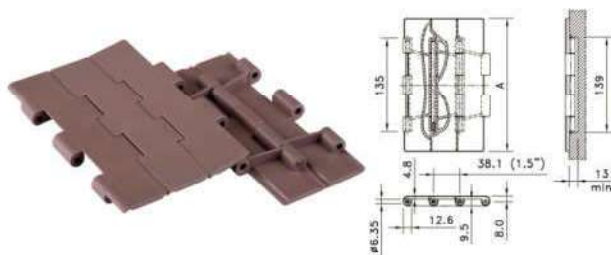

Unit:mm

Chain code	Name	K	Pitch	Materials
H821-K750	190 straight running chain	190.5	38.1	POM
H821-K1000	254 straight running chain	254	38.1	POM
H821-K1200	304 straight running chain	304.8	38.1	POM
H821Z-K750	190 straight running chain	190.5	38.1	POM
H821Z-K1000	254 straight running chain	254	38.1	POM
H821Z-K1200	304 straight running chain	304.8	38.1	POM

Plastic Flat Top Chain

H880

Non slip sideflexing chain



Chain Type 产品编号	Width (链宽)		Working Load(max) 工作载荷		Weight 重量	Sideflex Radius (min) 转弯半径		Backflex Radius(min) 反向转弯半径	
	mm	inch	N(21°C)	lbf(21°C)		mm	inch	mm	inch
880R-K325	82.6	3.25	2100	472	0.89	457	18	40	1.57
880R-K450	114.3	4.50			1.04				

H880TAB

Sideflexing chain

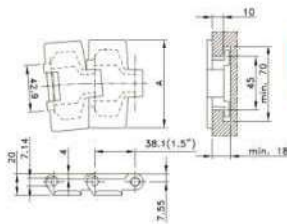

Unit:mm

Chain code	Name	K	R _{min}	Pitch	Materials
H880TAB-K325	82 sideflexing chain	82.5	457	38.1	POM
H880TAB-K350	89 sideflexing chain	88.9	480	38.1	POM
H880TAB-K400	101 sideflexing chain	101.6	500	38.1	POM
H880TAB-K450	114 sideflexing chain	114.3	610	38.1	POM
H880TABO-K450	114 sideflexing chain	114.3	500	38.1	POM

H880TABO

Sideflexing chain

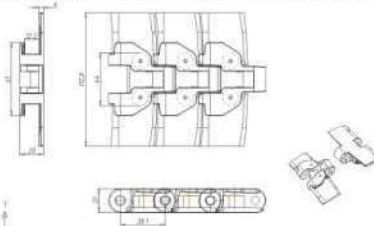

Chain Code 产品编号	Width 链宽		Working Load(max) 工作载荷		Weight 重量	Sideflex Radius (min) 弯曲半径		Backflex Radius(min) 反向转弯半径	
	mm	inch	N(21°C)	lbf(21°C)		mm	inch	mm	inch
H880TABO	114.3	4.50	2000	450	1.60	610	24.00	50	1.97

H880TAB

Sideflexing chain

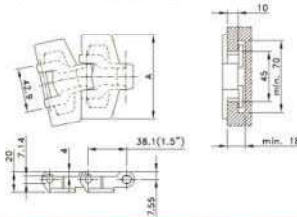

Chain Code 产品编号	Width 链宽		Working Load(max) 工作载荷		Weight 重量	Sideflex Radius (min) 弯曲半径		Backflex Radius(min) 反向转弯半径	
	mm	inch	N(21°C)	lbf(21°C)		mm	inch	mm	inch
880TAB BO-K325	82.6	3.25	2100	472	0.94	190	7.48	40	1.57
880TAB BO-K450	114.3	4.50			1.08				

H880BO

Sideflexing chain

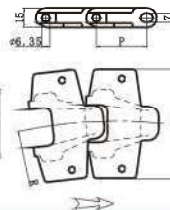

Unit:mm

Chain code	Name	K	R _{min}	Pitch	Materials
H880BO-K325	82 sideflexing chain	82.5	200	38.1	POM



H1775

Crecent sideflexing chain

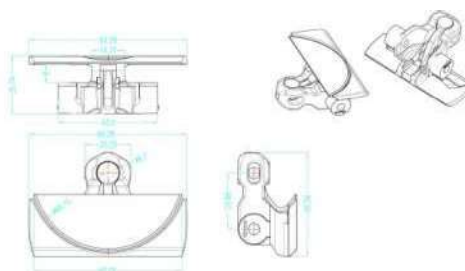

Chain Code 产品编号	Width 链宽		Thickness 厚度		Pitch 节距		Pin Material 销材料	Plastic Material 塑料材料
	mm	inch	mm	inch	mm	inch		
H1775	69.28	2.73	25.74	1.01	24.66	0.97	S.S	POM

H1770

Sideflexing chain

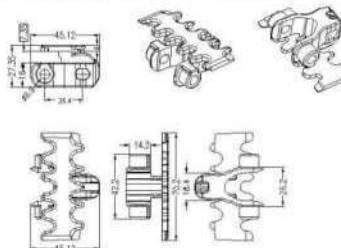

Chain Code 产品编号	Width 链宽		Thickness 厚度		Pitch 节距		Pin Material 销材料	Plastic Material 塑料材料
	mm	inch	mm	inch	mm	inch		
H1770	70.2	2.76	27.35	1.08	25.40	1.00	S.S	POM

H1050

Sideflexing flat top

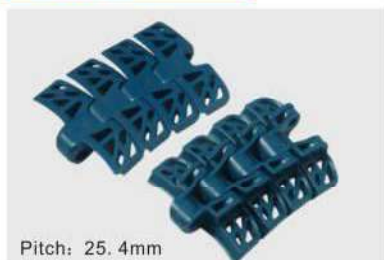

Pitch: 25.4mm

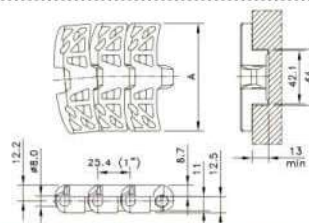

Chain Code 产品编号	Width 链宽		Working Load(max) 工作载荷		Weight 重量	Sideflex Radius (min) 弯曲半径		Backflex Radius(min) 反向转弯半径	
	mm	inch	N(21°C)	lbf(21°C)		mm	inch	mm	inch
H1050	83.8	3.30	1650	370	1.60	500	19.69	130	5.12

H1060

Sideflexing flat top



Pitch: 25.4mm

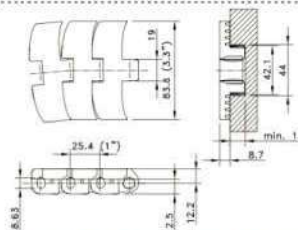

Chain Code 产品编号	Width 链宽		Working Load(max) 工作载荷		Weight 重量	Sideflex Radius (min) 弯曲半径		Backflex Radius(min) 反向转弯半径	
	mm	inch	N(21°C)	lbf(21°C)		mm	inch	mm	inch
H1060	83.8	3.30	1900	427	1.65	500	19.69	130	5.12

HPT250

Sideflexing flat top

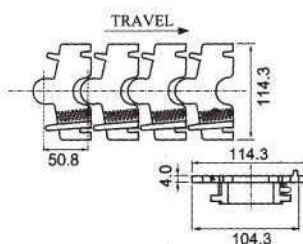

Chain Code 产品编号	Width 链宽		Working Load(max) 工作载荷	Weight 重量
	mm	inch		
HPT250	114.3	4.50	7200	3.20



H1108A

Knuckle chain

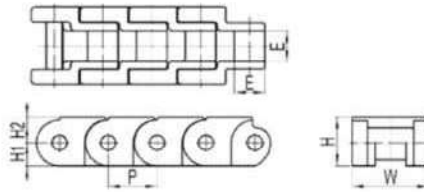

Unit:mm

Chain code	Name	W	H	Pitch P	Materials
H1108A	A knuckle chain	20	12	12.7	POM

H1108B

Knuckle chain

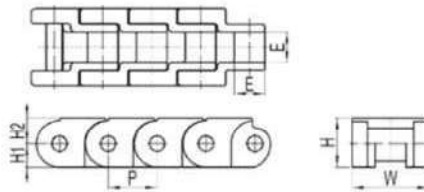

Unit:mm

Chain code	Name	W	H	Pitch P	Materials
H1108B	B knuckle chain	30	17	19.05	POM

H1108C

Double row small pitch chain

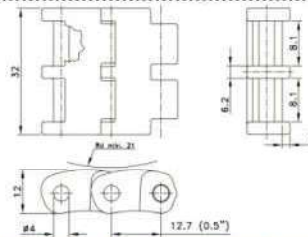

Chain Code 产品编号	Width 链宽		Working Load(max) 工作载荷		Weight 重量	Backflex Radius(min) 反向转弯半径	
	mm	inch	N(21°C)	lb(21°C)	Kg/m	mm	inch
H1108C	32	1.26	800	180	0.51	21	0.83

H880STAB

Sideflexing chain

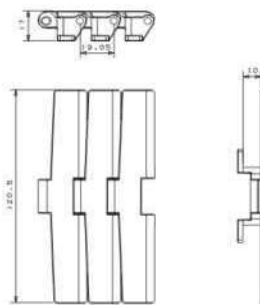

H880STABF

Sideflexing chain



Pitch: 19.05mm

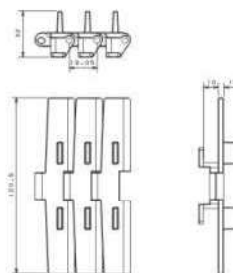



Plastic Flat Top Chain

H700

Straight running chain

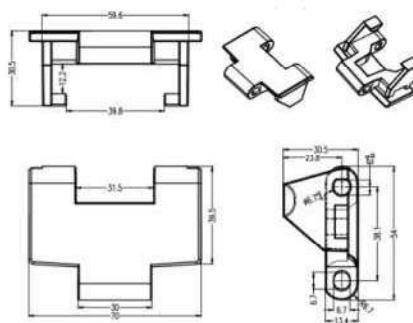

Chain Code 产品编号	Material 材质	Thickness 厚度		Pitch 节距		Width 链宽		Temperature 温度	
		mm	inch	mm	inch	mm	inch	dry	wet
H700	POM	13.4	0.527	38.1	1.5	70	2.755	+4 to +80°C	+4 to 65°C

H882TAB

Sideflexing flat top chains

H882TABF

Sideflexing flat top chains

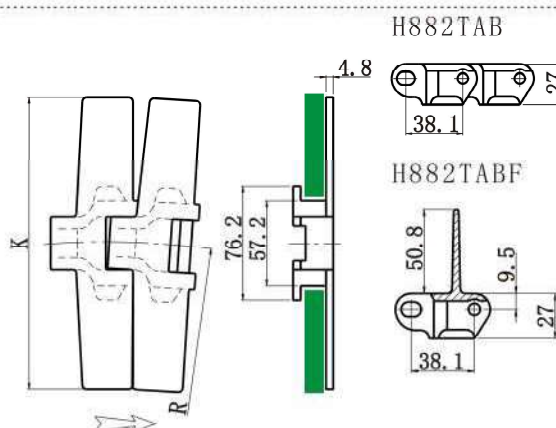

Unit:mm

Chain code	Name	K	R _{min}	Pitch	Materials
H882TAB-K600	152 sideflexing flat top chains	152.4	610	38.1	POM
H882TAB-K750	190 sideflexing flat top chains	190.5	610	38.1	POM
H882TAB-K1000	254 sideflexing flat top chains	254	610	38.1	POM
H882TAB-K1200	304 sideflexing flat top chains	304.8	610	38.1	POM
H882TABF-K1200	304 sideflexing flat top chains	304.8	610	38.1	POM

H882TAB-GD/DJ

Sideflexing chain

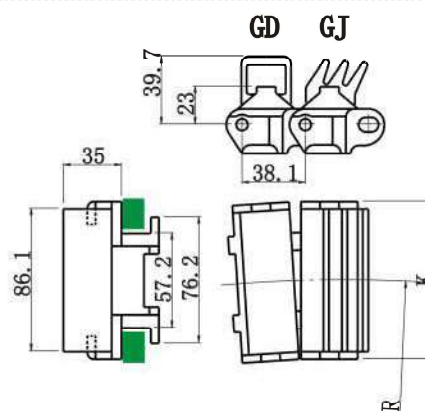

Unit:mm

Chain code	Name	K	R _{min}	Pitch	Materials
H882TAB-K375GD	95GD sideflexing chain	95.3	610	38.1	POM
H882TAB-K375GJ	95GJ sideflexing chain	95.3	610	38.1	POM

HBP821 Roller top straight belt

HBP821 Roller top straight belt



HBP821 HBP821

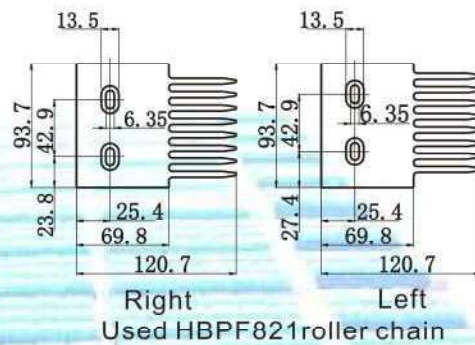
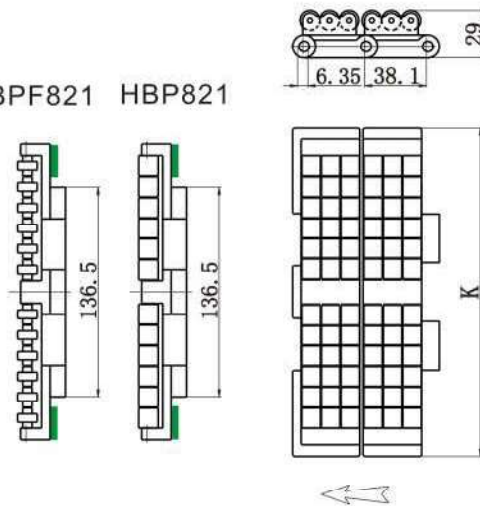

Right Left
Used HBP821 roller chain

Unit:mm

Chain code	Name	K	Pitch	Materials
HBP821-K750	190 roller top straight belt	190.5	38.1	POM
HBP821-K1000	254 roller top straight belt	254	38.1	POM
HBP821-K1200	304 roller top straight belt	304.8	38.1	POM
HBP821-K750	190 roller top straight belt	190.5	38.1	POM
HBP821-K1000	254 roller top straight belt	254	38.1	POM
HBP821-K1200	304 roller top straight belt	304.5	38.1	POM



Roller Chain

H8275

Roller top straight belt

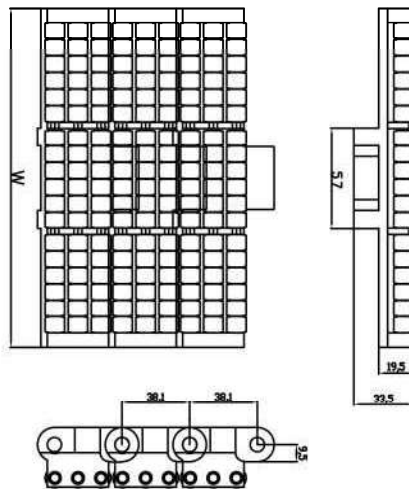

Belt Type 型号	Plate Width 链板宽(W)		Working Load(max) 工作载荷		Weight 重量 kg/m	Backflex Radius(mm) 反向转弯半径	
	mm	inch	N/m(21°C)	lb/ft (21°C)		mm	inch
H8275-K750	190.5	7.5	10000	860	5.65	400	15.75
H8275-K1000	254	10			7.2		
H8275-K1200	304.8	12			8.1		

HBP882

Roller top straight belt

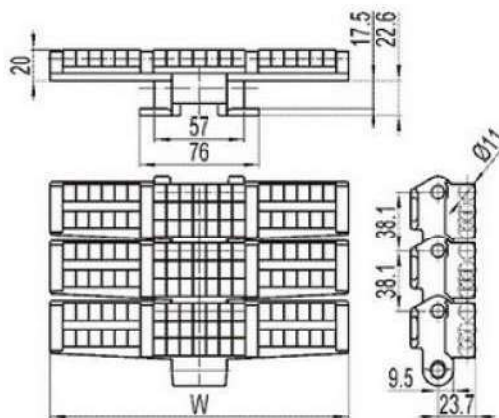
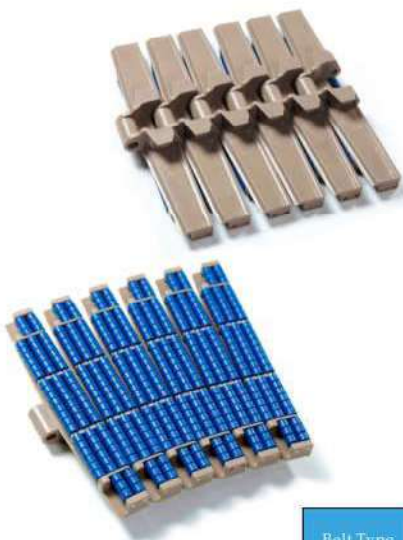

Belt Type 型号	Plate Width 链板宽(W)		Working Load(max) 工作载荷		Sideflex radius(min) 转弯半径		Backflex Radius(mm) 反向转弯半径	
	mm	inch	N/m(21°C)	lb/ft (21°C)	mm	inch	mm	inch
HBP882TAB-K750	190.5	7.5	3830	860	609.6	24	400	15.75
HBP882TAB-K1000	254	10			680	26.8		
HBP882TAB-K1200	304.8	12			680	26.8		

H1700

52Knuckle chain

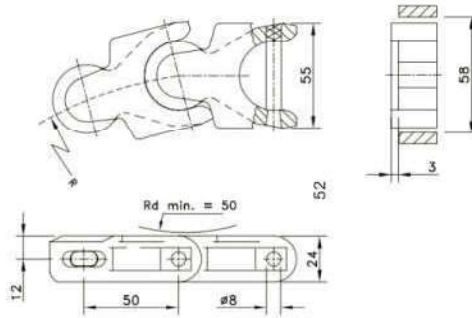

Chain Code 产品编号	Width 链宽		Working Load(max) 工作载荷		Weight 重量	Sideflex Radius (min) 弯曲半径		Backflex Radius(min) 反向转弯半径	
	mm	inch	N(21℃)	lbf(21℃)		mm	inch	mm	inch
H1700	55	2.17	2670	600	1.26	140	5.51	38	1.50

H1702

53Knuckle chain

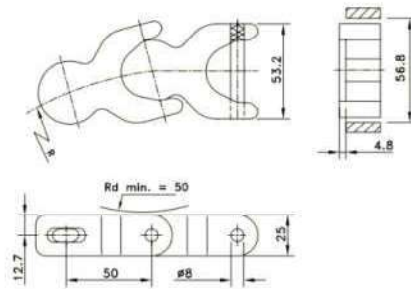

Chain Code 产品编号	Width 链宽		Working Load(max) 工作载荷		Weight 重量	Sideflex Radius (min) 弯曲半径		Backflex Radius(min) 反向转弯半径	
	mm	inch	N(21℃)	lbf(21℃)		mm	inch	mm	inch
H1702	53	2.09	2670	600	1.43	140	5.51	38	1.50

H1702TAB

67Knuckle chain

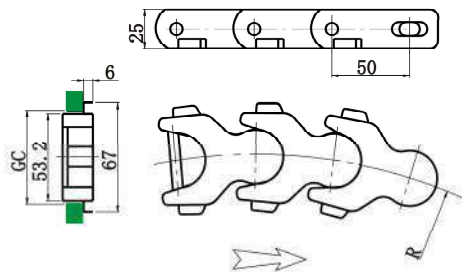

Unit:mm

Chain code	Name	垫条内宽GC		R min	Pitch	Materials
		直	弯			
H1702TAB	67Knuckle chain	58	55	140	50	POM



Plastic Knuckle Chain

HA600 Knuckle chain

HA1400 Knuckle chain

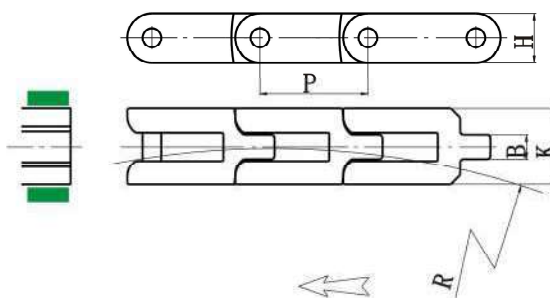

Unit:mm

Chain code	Name	K	B	R _{min}	H	Pitch P	Materials
HA 600	H600 knuckle chain	43	14.3	600	29	63.5	POM
HA 1400	H1400 knuckle chain	50	15.9	600	38	82.5	POM

HA600TAB Knuckle chain

HA1400TAB Knuckle chain

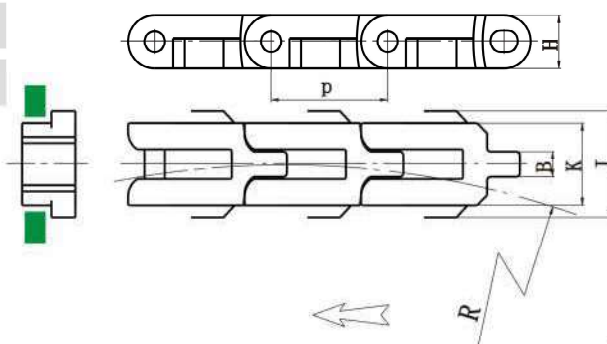

Unit:mm

Chain code	Name	K	B	R	H	G	Pitch P	Materials
HA 600TAB	H600 knuckle chain	43	14.3	600	29	18	63.5	POM
HA 1400TAB	H1400 knuckle chain	50	15.9	600	38	19	82.5	POM

H2012 Case Chain

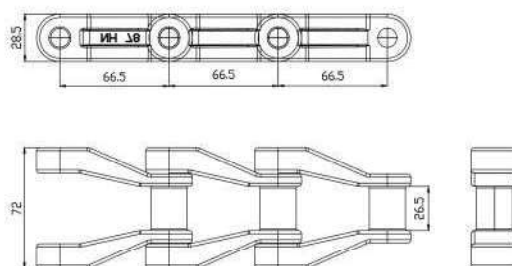

Stainless Steel Base Plastic Chain

H1853

Stainless steel based straight running chain

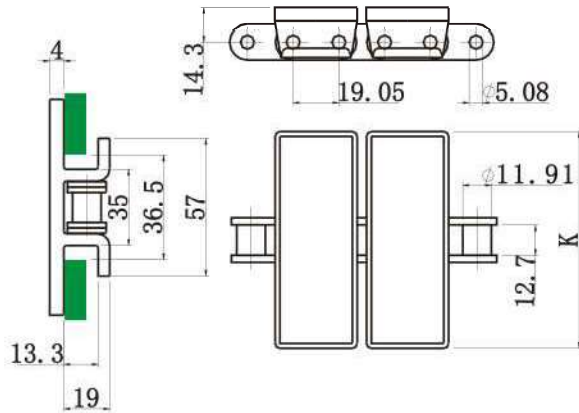
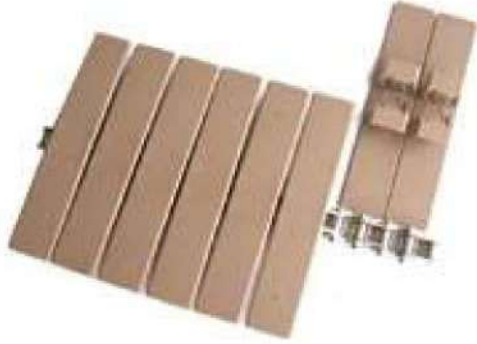

Unit:mm

Chain code	Name	K	Pitch	Materials
H1853-K325	82 stainless steel based straight running chain	82.5	19.05	POM
H1853-K450	114 stainless steel based straight running chain	114.3	19.05	POM
H1853-K600	152 stainless steel based straight running chain	152.5	19.05	POM
H1853-K750	190 stainless steel based straight running chain	190.5	19.05	POM

H963

Stainless steel based straight running chain

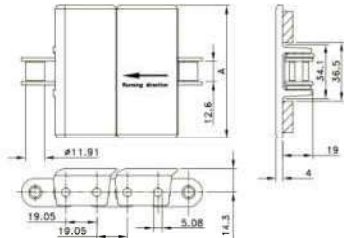

Chain Code 产品编号	Width 链宽		Working Load(max) 工作载荷		Weight 重量 Kg/m
	mm	inch	N(21°C)	lbf(21°C)	
963-K325	82.6	3.25	2700	607	2.10
963-K450	114.3	4.50			2.23
963-K600	152.4	6.00			2.53
963-K750	190.5	7.50			2.68

H1863

Stainless steel based sidflexing chain

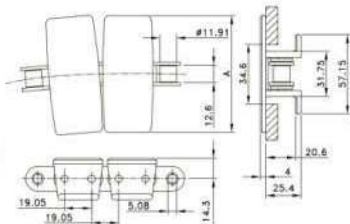
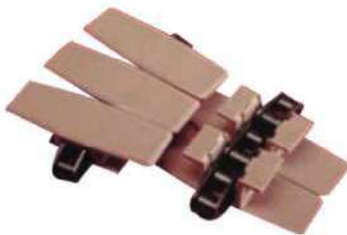

Chain Code 产品编号	Width 链宽		Working Load(max) 工作载荷		Weight 重量 Kg/m	Sidflex R(min) 转弯半径	
	mm	inch	N(21°C)	lbf(21°C)		mm	inch
1873-K325	82.6	3.25	4500	1011	2.10	356	14
1873-K450	114.3	4.50			2.30		
1873-K600	152.4	6.00			2.40		
1873-K750	190.5	7.50			2.60	457	18
1873-K1000	254	10.00			2.80		
1873-K1200	304.8	12.00	3.00	610	24		



Stainless Steel Base Plastic Chain

H1873

Stainless steel based sideflexing chain

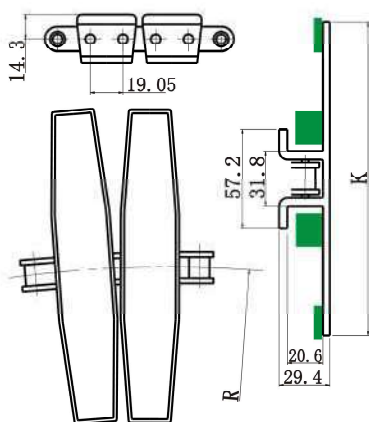

H1873Z

Stainless steel based sideflexing chain



Unit:mm

Chain code	Name	K	R min	Pitch	Materials
H1873-K325	82 stainless steel based sideflexing chain	82.5	610	19.05	POM
H1873-K450	114 stainless steel based sideflexing chain	114.3	610	19.05	POM
H1873-K600	152 stainless steel based sideflexing chain	152.5	610	19.05	POM
H1873-K750	190 stainless steel based sideflexing chain	190.5	610	19.05	POM
H1873-K1000	254 stainless steel based sideflexing chain	254	610	19.05	POM
H1873-K1200	304 stainless steel based sideflexing chain	304.8	610	19.05	POM
H1873-K1575	400 stainless steel based sideflexing chain	400	610	19.05	POM
H1873Z-K750	190 stainless steel based sideflexing chain	190.5	610	19.05	POM
H1873Z-K1000	254 stainless steel based sideflexing chain	254	610	19.05	POM
H1873Z-K1200	304 stainless steel based sideflexing chain	304.8	610	19.05	POM

H402

Spiral machine long chain plate with pad

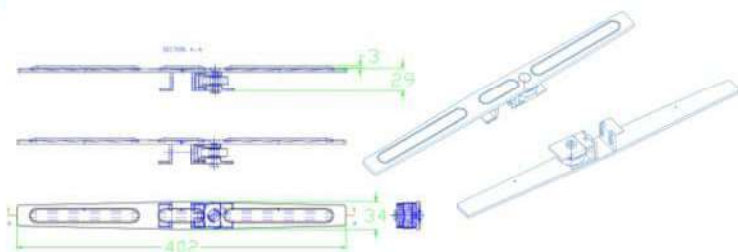

Chain Code 产品编号	Material 材质	Rubber Thickness 胶厚度		Belt width 链宽		Roller thickness 滚珠厚度		Temperature 温度	
		mm	inch	mm	inch	mm	inch	dry	wet
H402	POM+SS	3	0.118	402	15.82	29	1.14	+4 to +80°C	+4 to 65°C

H1873GD

Stainless steel based sideflexing chain

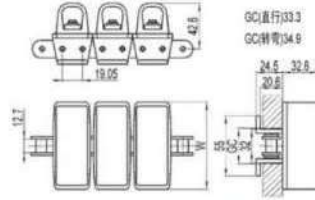

Chain Code 产品编号	ID		Width 链宽		Working Load(max) 工作载荷		Weight 重量	Sideflex R(min) 转弯半径		Backflex Radius(min) 反向弯曲半径	
	mm	inch	mm	inch	N(21°C)	lbf(21°C)		mm	inch	mm	inch
1873GD-K325	78.5	3.25	82.6	3.25	3400	765	2.9	356	14	150	2.90
1873GD-K450	106	4.50	114.3	4.50			3.5	356	14		
1873GD-K600	150	6.00	152.4	6.00			4.1	457	18		
1873GD-K750	190	7.50	190.5	7.50			4.5	457	18		

H1873GJ

Stainless steel based sideflexing chain

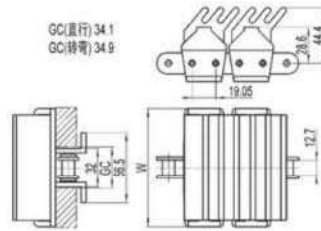

Chain Type 产品编号	Width 链宽		Working Load(max) 工作载荷		Weight 重量	Sideflex Radius (min) 转弯半径		Backflex Radius(min) 反向弯曲半径	
	mm	inch	N(21°C)	lbf(21°C)		mm	inch	mm	inch
1873GJ-K375	95.3	3.75	3400	765	2.24	381	15	150	5.90

HJ2013

Dishwasher chain plate

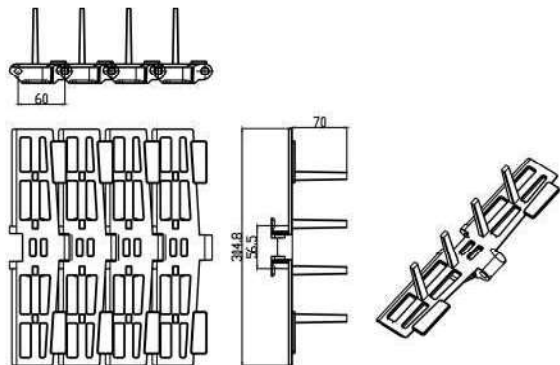



Stainless Steel Chain

HS512

Steel table straight running chain

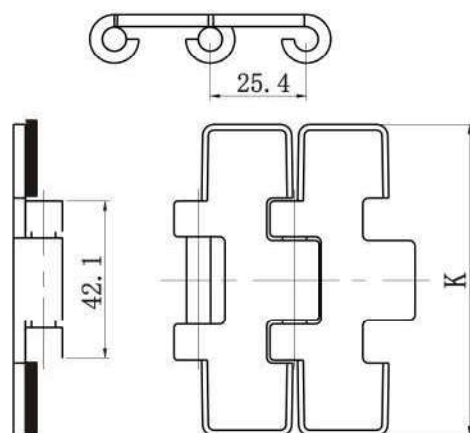

Unit:mm

Chain code	Name	K	Pitch	Materials
HS512-K217	55 steel table straight running chain	55	25.4	2Cr13
HS512-K250	63 steel table straight running chain	63.5	25.4	2Cr13
HS512-K325	82 steel table straight running chain	82.5	25.4	2Cr13

HS815

Steel table straight running chain

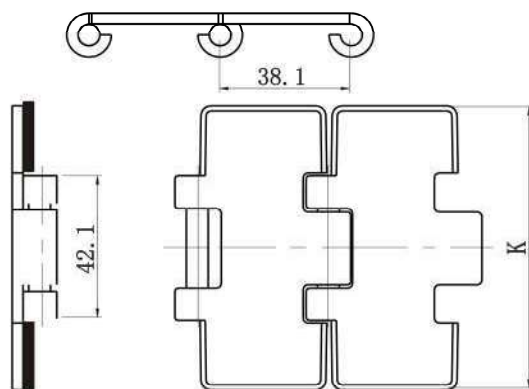

Unit:mm

Chain code	Name	K	Pitch	Materials
HS815-K125	32 steel table straight running chain	32	38.1	2Cr13
HS815-K175	44 steel table straight running chain	44.5	38.1	2Cr13
HS815-K325	82 steel table straight running chain	82.5	38.1	2Cr13
HS815-K400	101 steel table straight running chain	101.6	38.1	2Cr13
HS815-K450	114 steel table straight running chain	114.3	38.1	2Cr13
HS815-K600	152 steel table straight running chain	152.4	38.1	2Cr13
HS815-K750	190 steel table straight running chain	190.5	38.1	2Cr13

HS881M

Steel table sideflexing chain

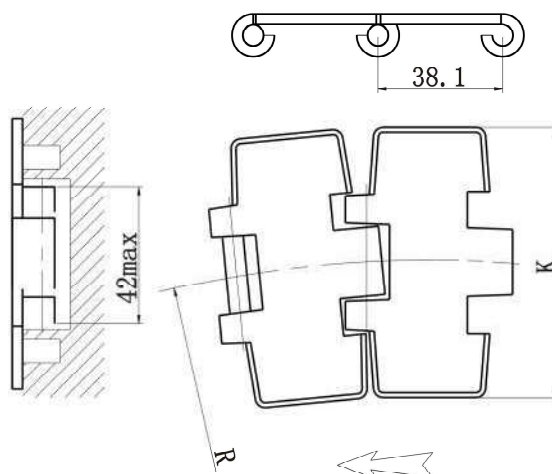

Unit:mm

Chain code	Name	K	R _{min}	Pitch	Materials
HS881M-K325	82 steel table sideflexing chain	82.5	457	38.1	2Cr13
HS881M-K450	114 steel table sideflexing chain	114.3	500	38.1	2Cr13
HS881M-K600	152 steel table sideflexing chain	152.4	500	38.1	2Cr13
HS881M-K750	190 steel table sideflexing chain	190.5	500	38.1	2Cr13

HS881TAB

Steel table sideflexing chain

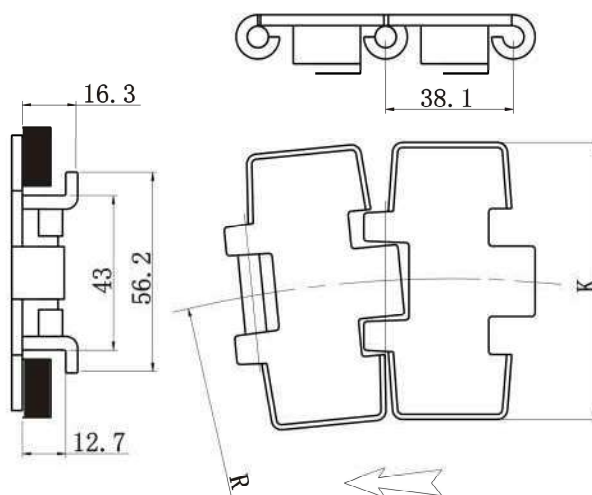

Unit:mm

Chain code	Name	K	R _{min}	Pitch	Materials
HS881TAB-K325	82 steel table sideflexing chain	82.5	457	38.1	2Cr13
HS881TAB-K450	114 steel table sideflexing chain	114.3	610	38.1	2Cr13
HS881TAB-K600	152 steel table sideflexing chain	152.4	610	38.1	2Cr13
HS881TAB-K750	190 steel table sideflexing chain	190.5	610	38.1	2Cr13



Stainless steel chain plastic surface

HS802Z

Steel table straight running chain

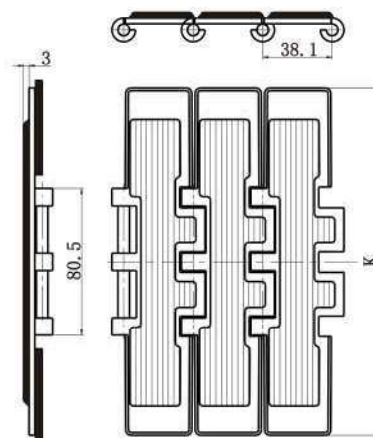
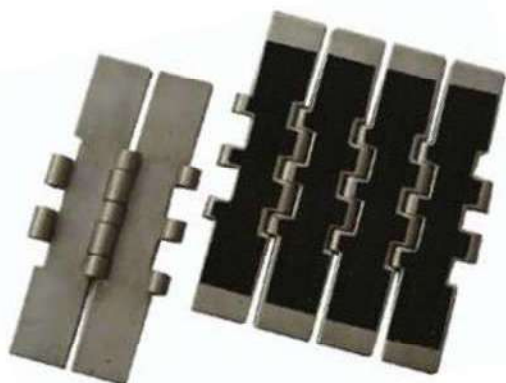

Unit:mm

Chain code	Name	K	Pitch	Materials
HS802Z-K750	190 steel table straight running chain	190.5	38.1	2Cr13

HS881TABZ

Steel table sideflexing chain

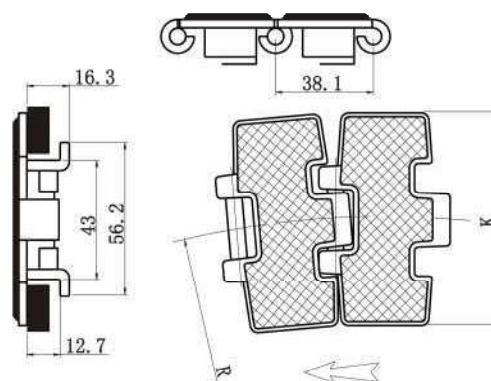

Unit:mm

Chain code	Name	K	R _{min}	Pitch	Materials
HS881TABZ-K325	82 steel table sideflexing chain	82.5	457	38.1	2Cr13

H-PC

Small pitch roller chain

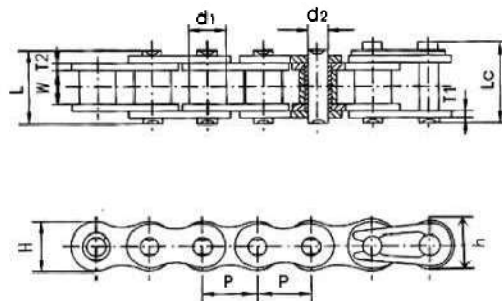

Chain Code 产品编号	P	d1	W	d2	L	Lc	H	T2	h	T1	Working Load(max) 工作载荷
	mm	mm	mm	mm	mm	mm	mm	mm	mm	mm	N
H-PC35	9.525	4.67	5.55	5.55	14.1	16.2	9	2.2	7.8	1.2	1175
H-PC40	12.70	7.85	7.94	7.94	16.6	18.8	12.0	1.5	10.4	1.5	4320
H-PC50	15.857	9.4	10.16	10.16	20.8	23	15.0	2.0	13.0	2.0	6720
II-PC60	19.05	12.60	11.91	11.91	26.2	28.5	18.1	2.4	15.6	2.5	8640

XS44

Flexible chain

XL63

Flexible chain



Pitch: 25.4mm

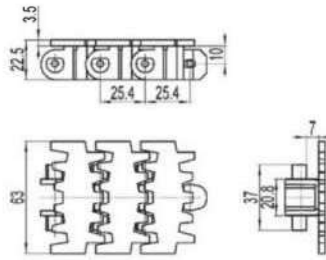

Chain Type 产品编号	Width (链宽)		Working Load(max) 工作载荷		Weight 重量	Sideflex Radius (min) 转弯半径		Backflex Radius(min) 反向转弯半径	
	mm	inch	N(21°C)	lbf(21°C)		mm	inch	mm	inch
XS44	44	2.48	500	112	0.5	150	5.91	40	1.57
XL63	63	2.48	500	112	0.8	150	5.91	40	1.57

XM83

Flexible chain

XH103

Flexible chain



Pitch: 25.4mm

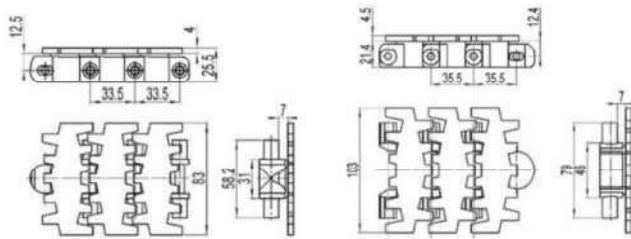

Chain Type 产品编号	Width (链宽)		Working Load(max) 工作载荷		Weight 重量	Sideflex Radius (min) 转弯半径		Backflex Radius(min) 反向转弯半径	
	mm	inch	N(21°C)	lbf(21°C)		mm	inch	mm	inch
XM83	83	3.25	1250	281	1.23	160	6.30	40	1.57
XH103	103	4.06	1250	281	1.76	170	6.70	40	1.57

